



YUCCA

www.yucca.com.ar



Escucha al hombre que trabaja con sus manos,
puede que te enseñe una mejor manera de hacerlo.

*Listen to the man who works with his hands.
He may be able to show you a better way to do it.*

- Louis I. Kahn -

▶ 01

Lámpara de pie
Jazz

▶ 02

Lámpara de mesa
Loto

▶ 03

Lámpara de colgar
Oslo

01 ▶

02 ▶

03 ▶



Indice

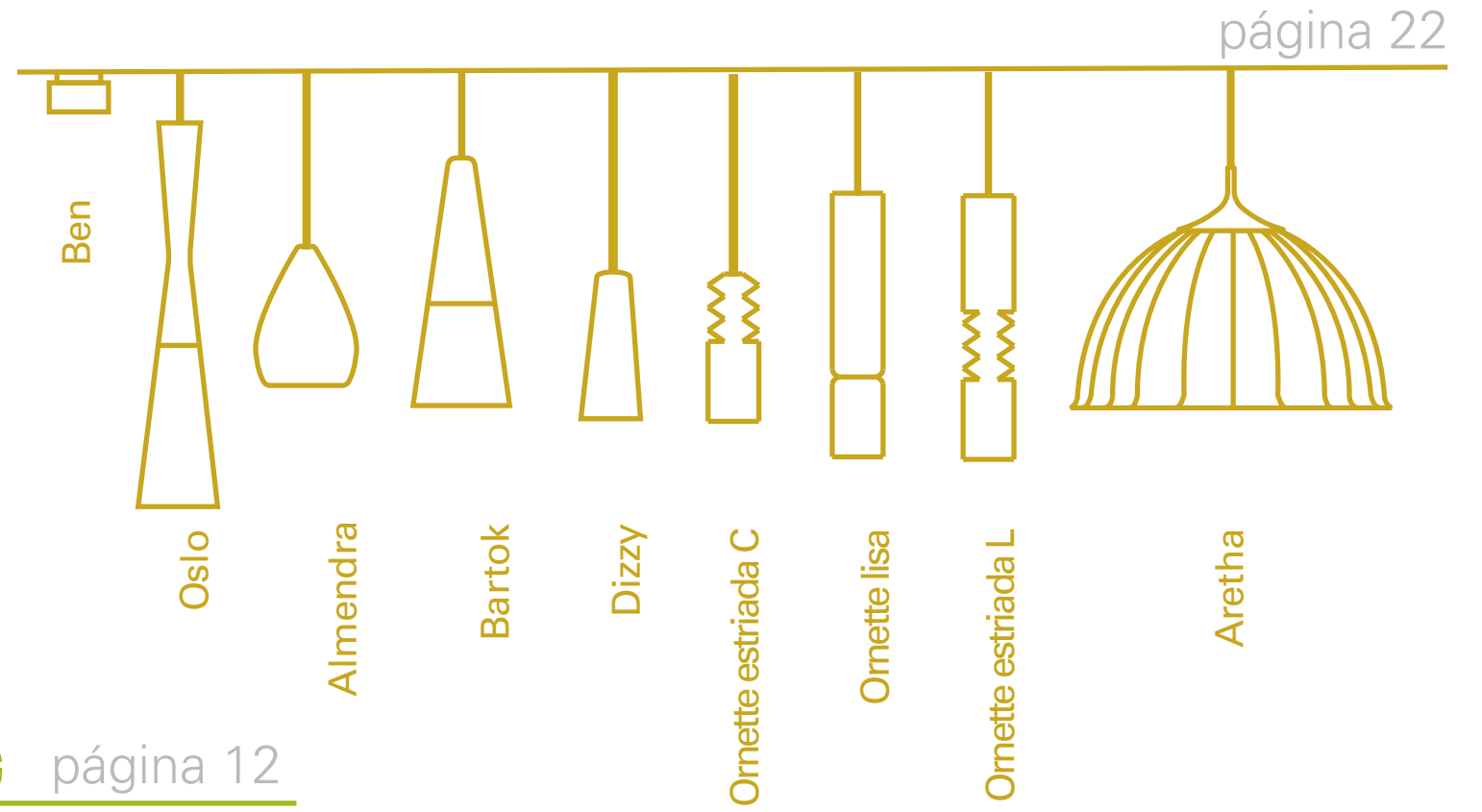
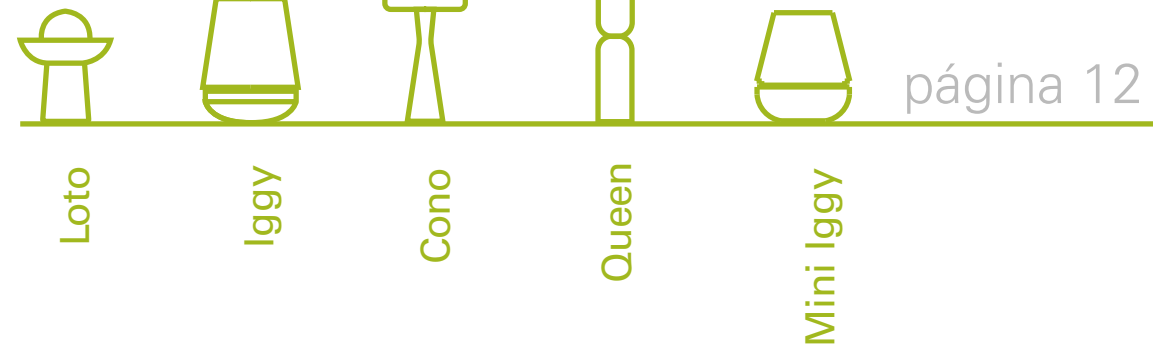
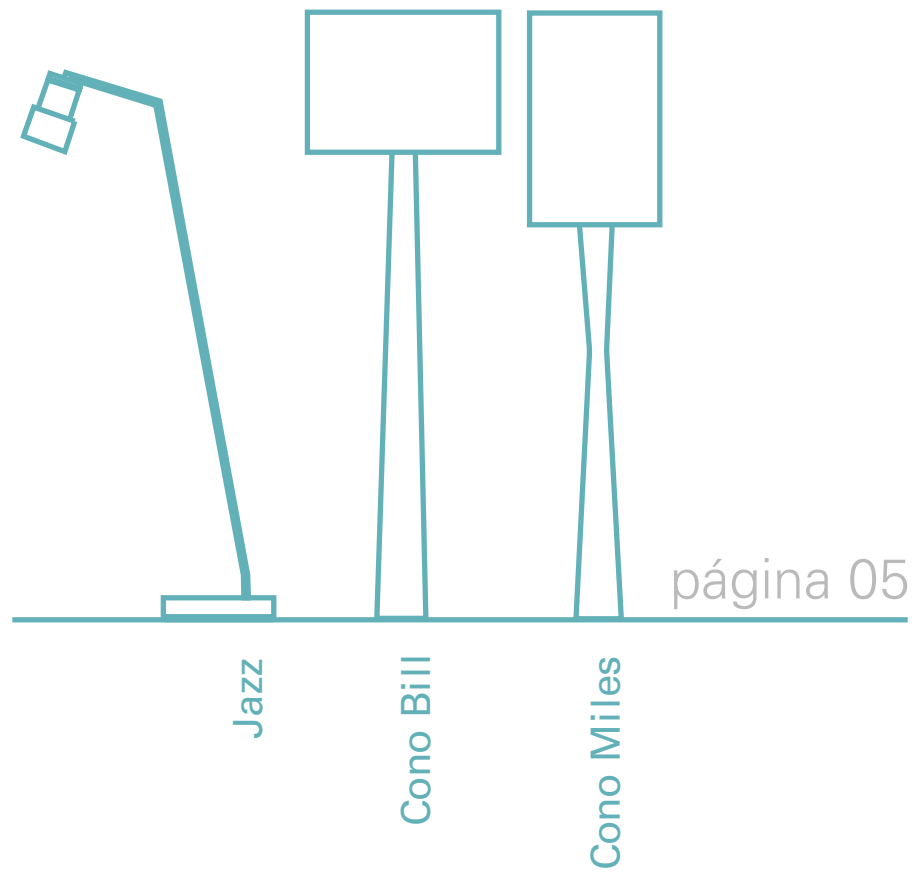

Lámparas de pie

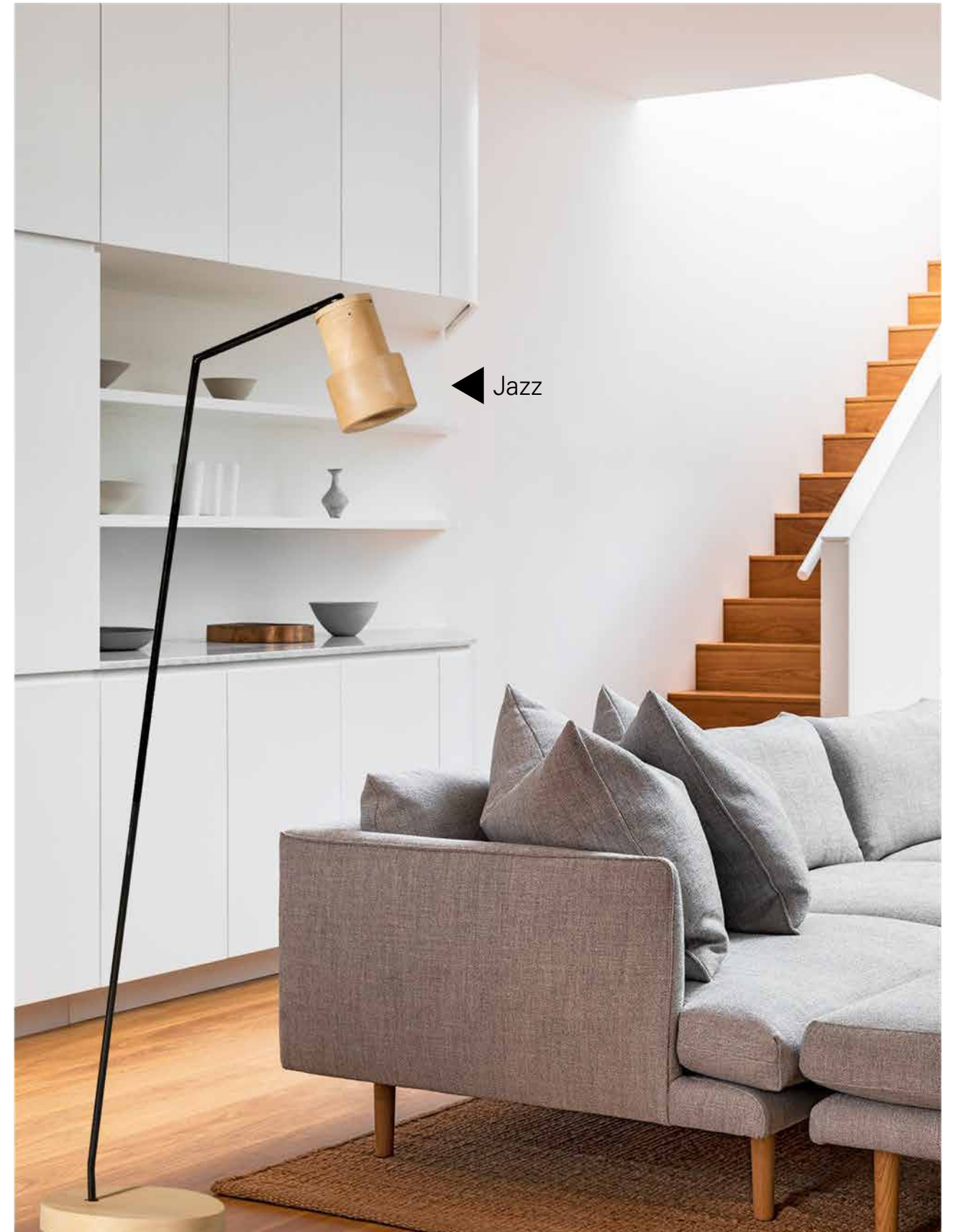

Jazz



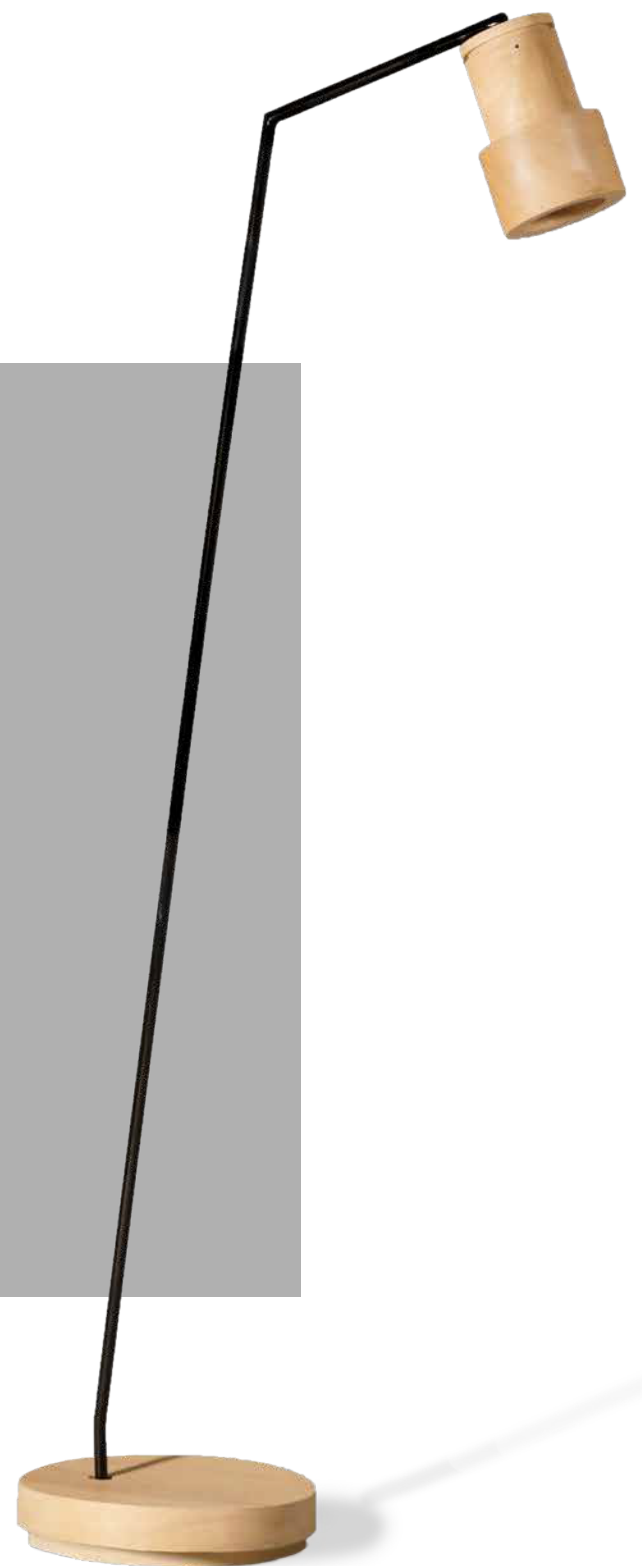

Jazz

Estructura en caño de hierro redondo.
Base y spot en madera de lenga torneada.
Lámpara E27 LED.

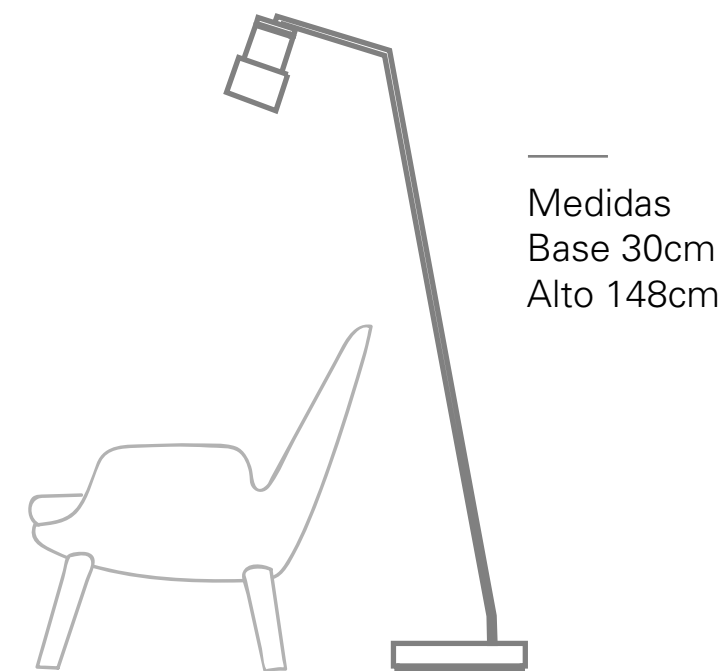

Medidas
Base 30cm
Alto 148cm



Cono Bill

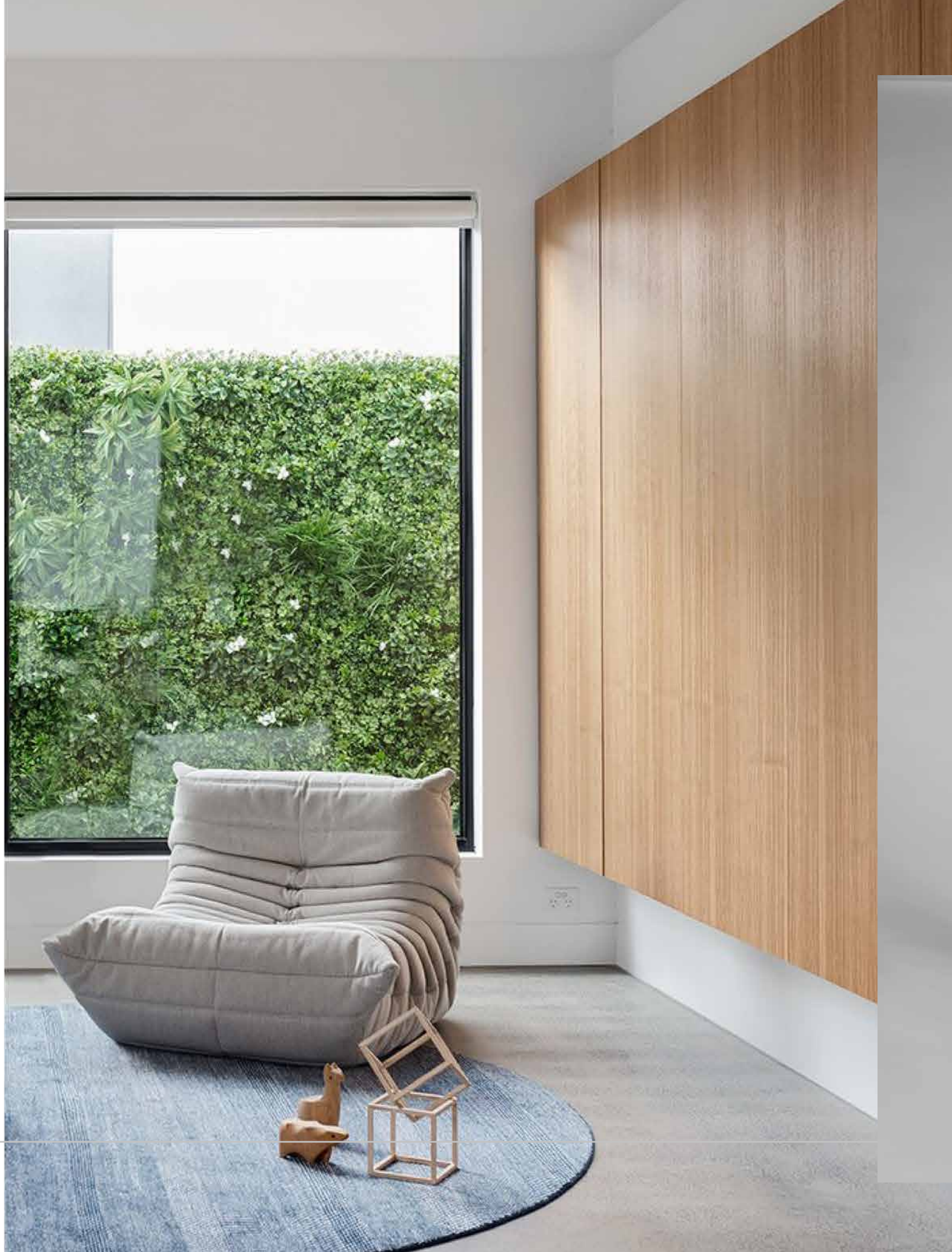



Cono Bill

Base en madera maciza de lenga torneada.
Terminación hidrolaca natural.
Pantalla lino.
Lámpara E27 LED.

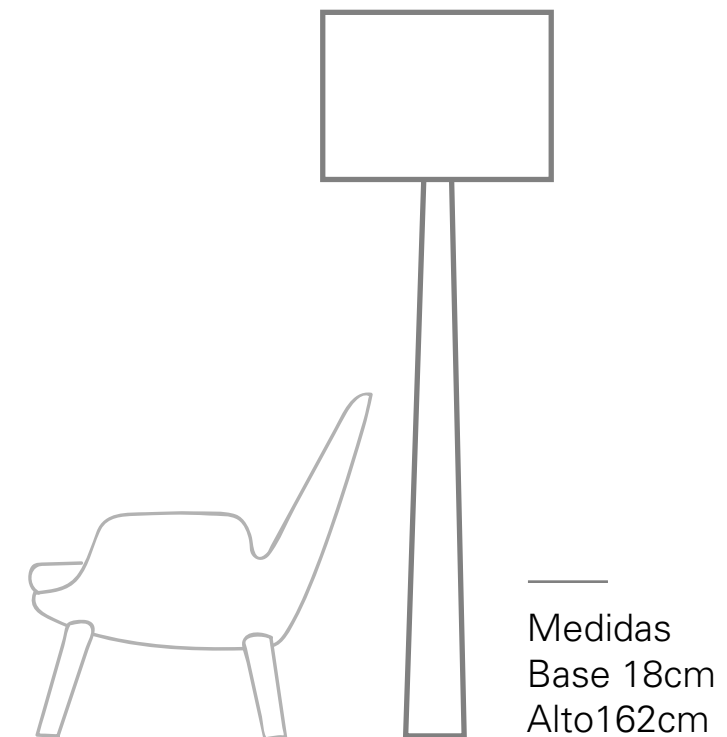

Cono Miles

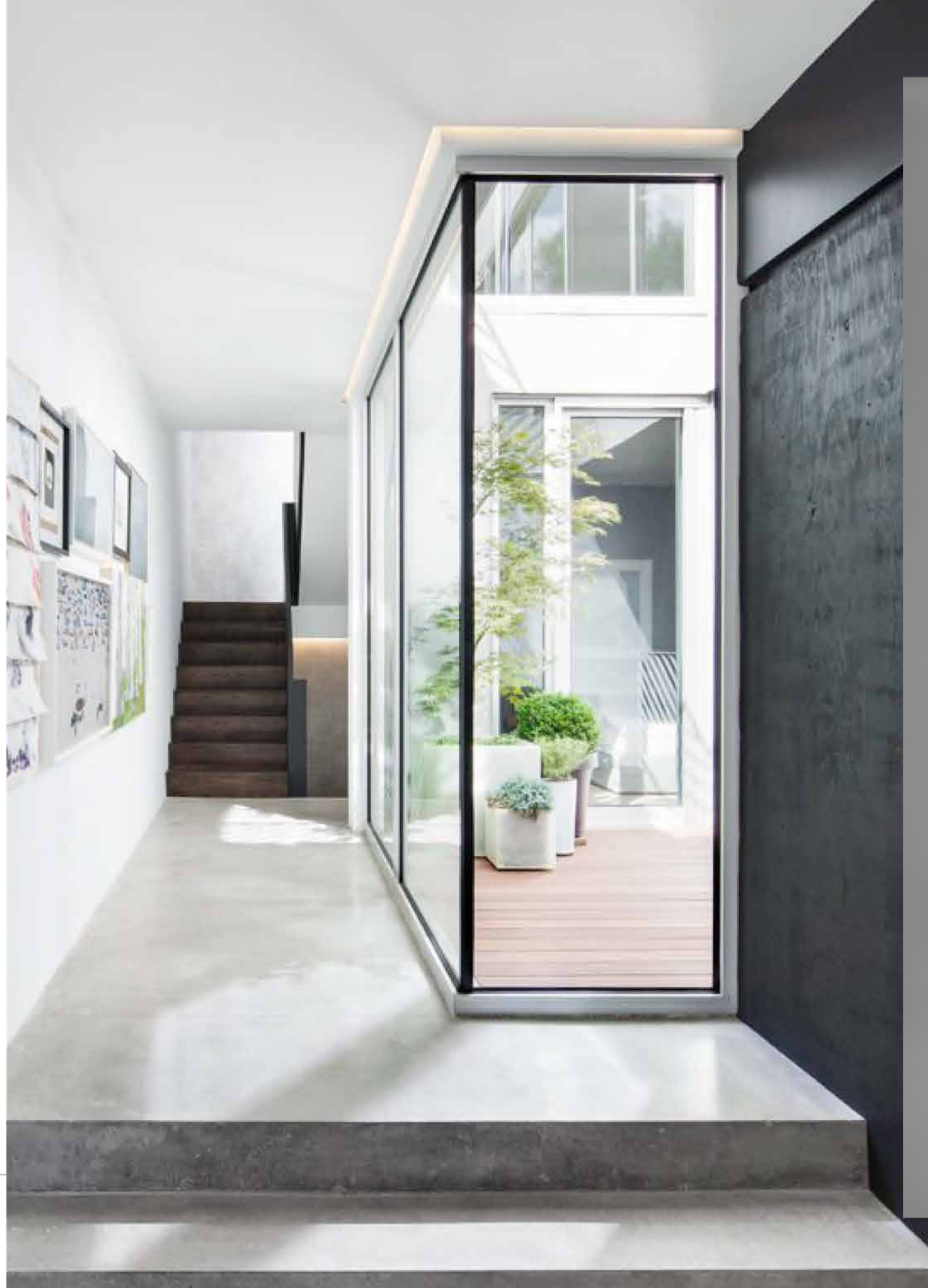



Cono Miles

Base en madera maciza de lenga torneada.
Terminación hidrolaca natural o negro.
Pantalla lino.
Lámpara E27 LED.

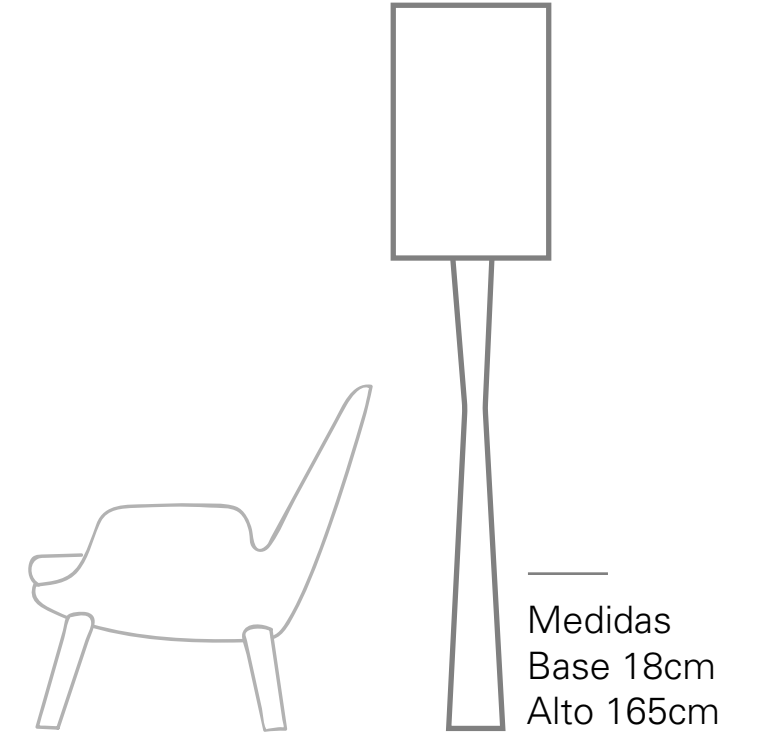

Lámparas de mesa

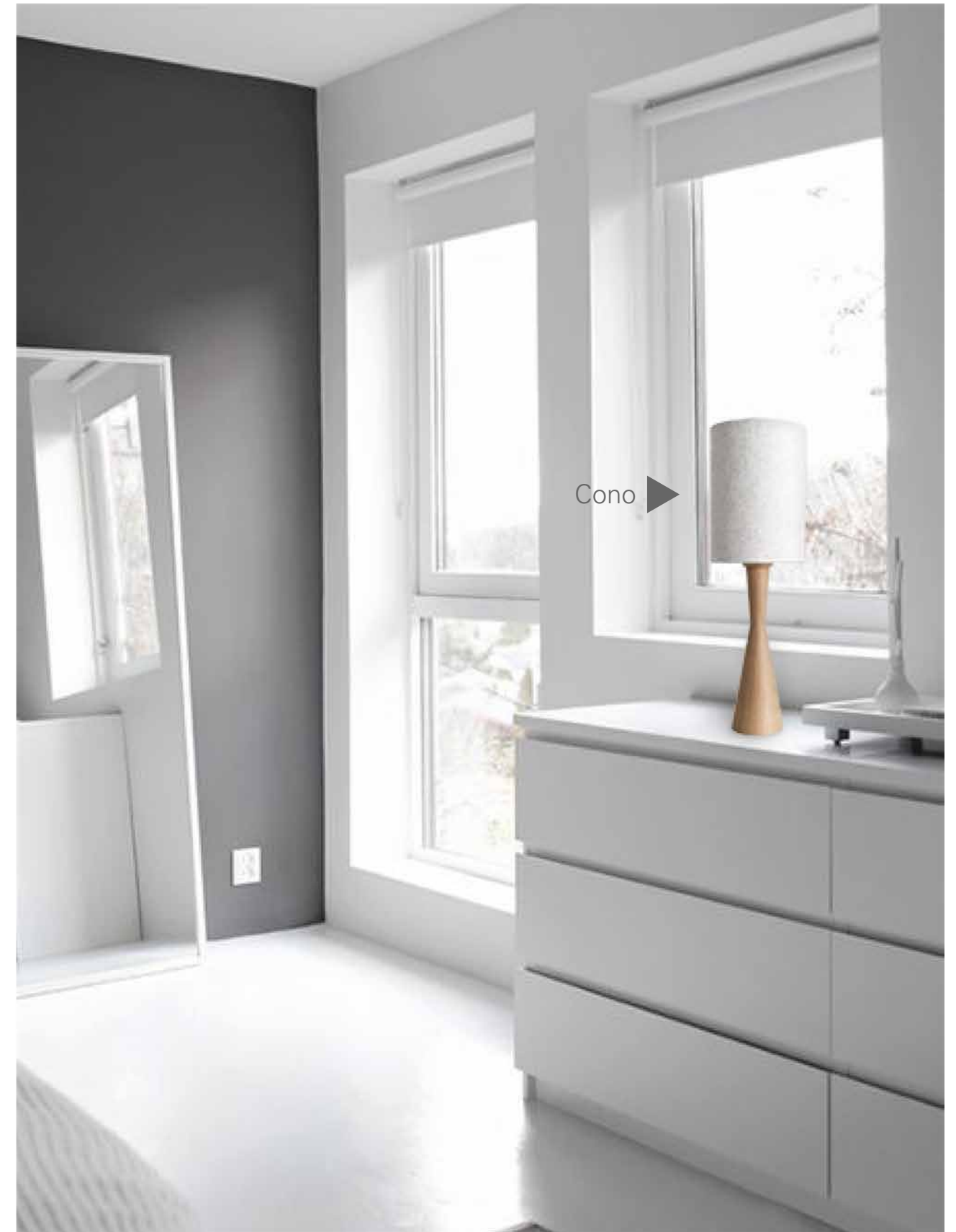

Cono

Loto

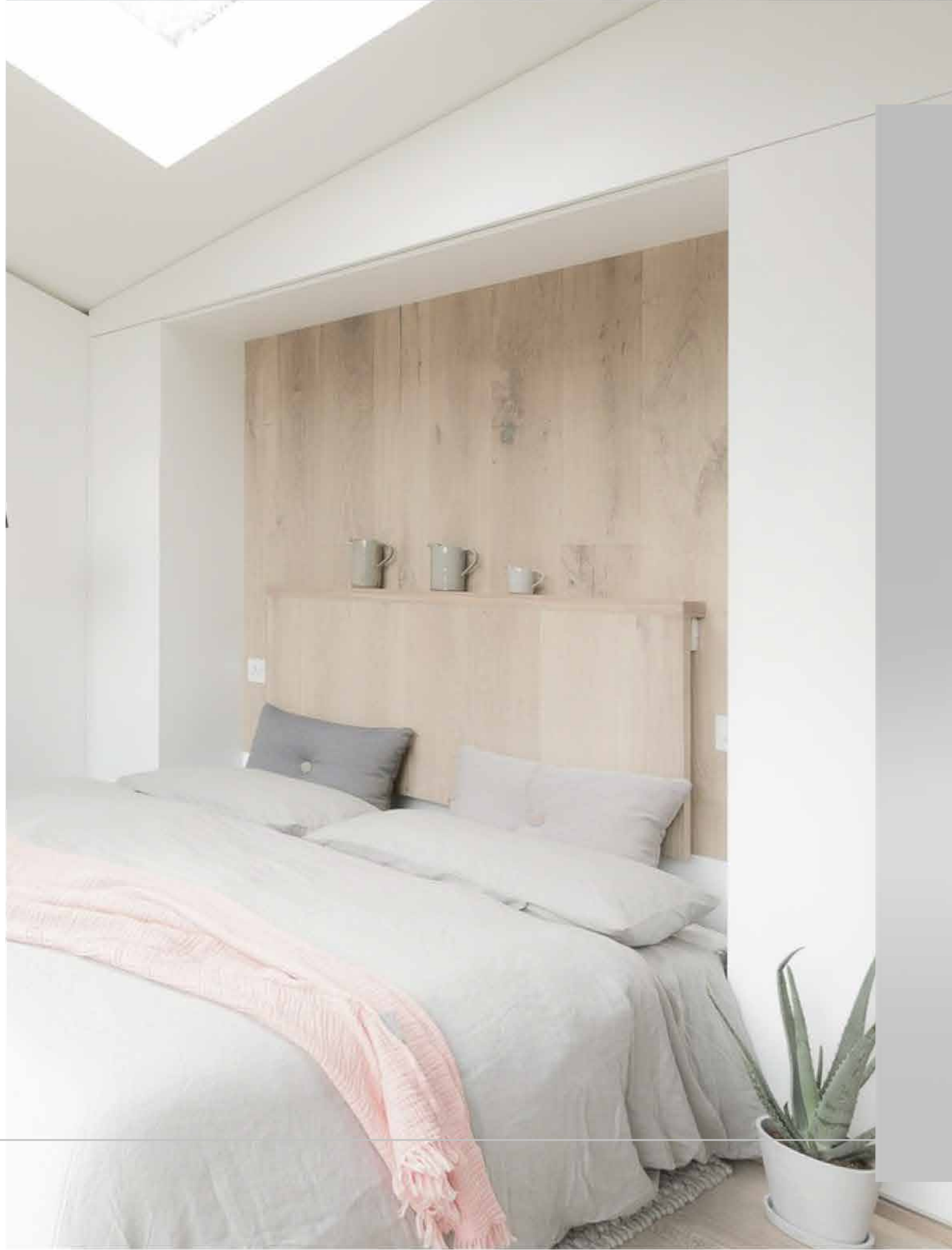



Loto

Pieza torneada en madera maciza de lenga.
Terminación hidrolaca natural.
Globo cristal opal.
Lámpara E27 LED.

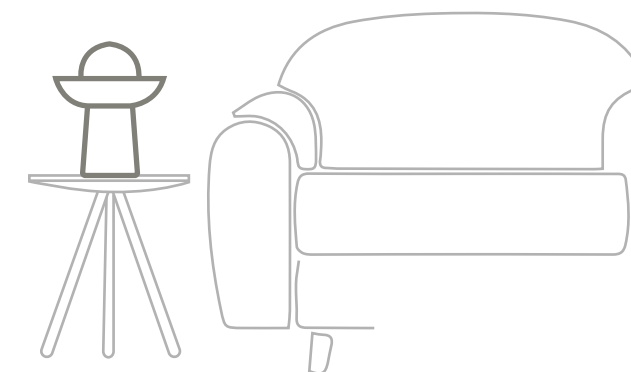

Medidas
Ancho 9cm
Alto 22cm



lggy





Iggy

Base de madera lenga torneada.
Terminación hidrolaca natural.
Pantalla en lino, color gris, negro, blanco.
Lámpara E27 LED.



Medidas
Base 20cm
Alto 24cm

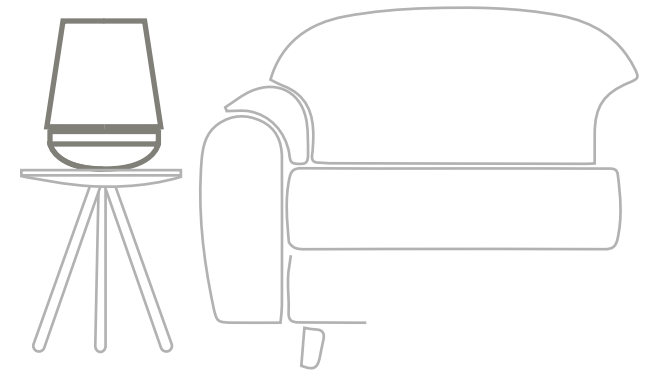



Mini Iggy

Base de madera de lenga torneada
Terminación hidrolaca natural.
Pantalla impresión 3D, material PLA, color blanco.
Lámpara E27 LED

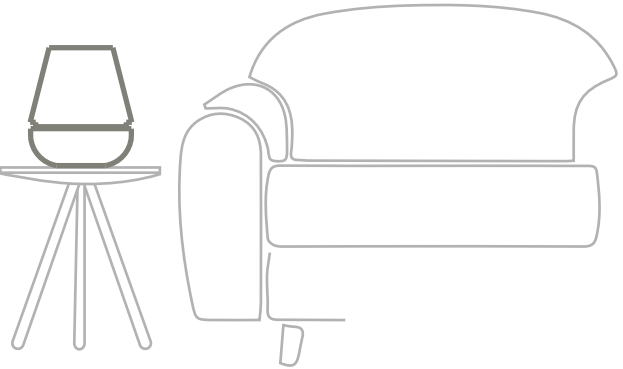

Measures
Base 15cm
High 18cm



Cono





Cono de mesa

Base torneada en madera de lenga.
Terminación hidrolaca natural.
Pantalla lino o funda tejida blanco.
Lámpara E27 LED.

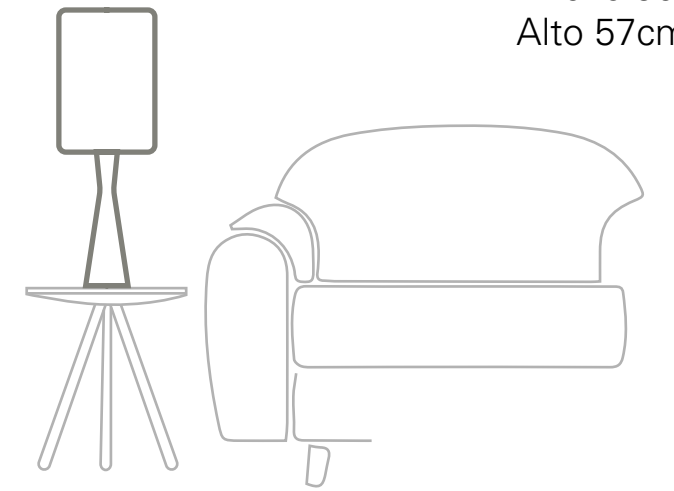

Medidas
Ancho 9cm
Alto 57cm



Queen





Base torneada en madera de lenga.
Terminación hidrolaca natural.
Pantalla lino.
Lámpara E27 LED.

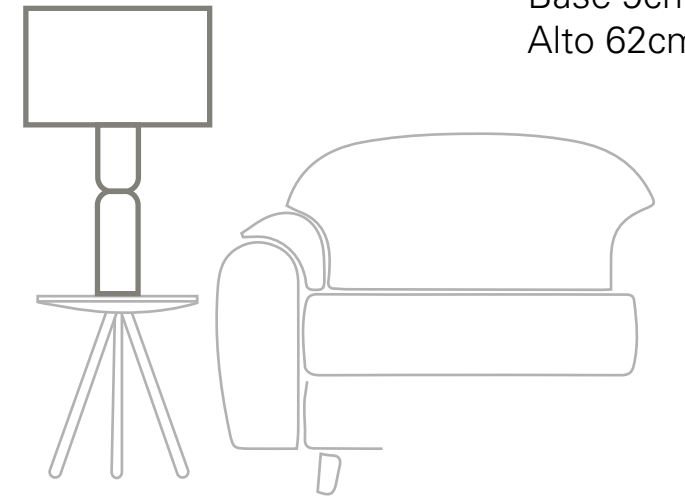

Medidas
Base 9cm
Alto 62cm



Lámparas de colgar



Oslo





Oslo

Pieza en madera maciza de lenga torneada.
Terminación hidrolaca natural.
Lámpara E27 LED.

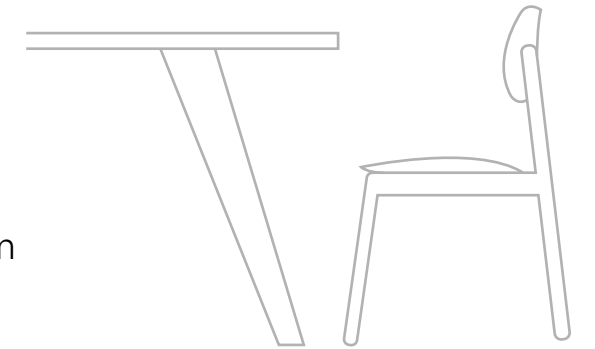
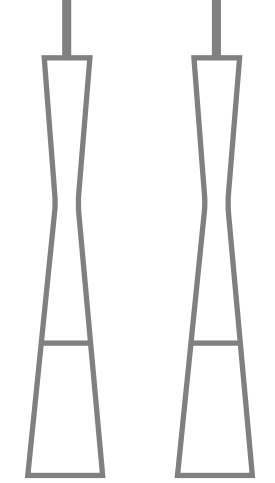

Medidas
Ancho 18cm
Alto 90cm



Almendra





Almendra

Pieza en lenga maciza torneada.
Terminación hidrolaca natural.
Lámpara E27 LED.

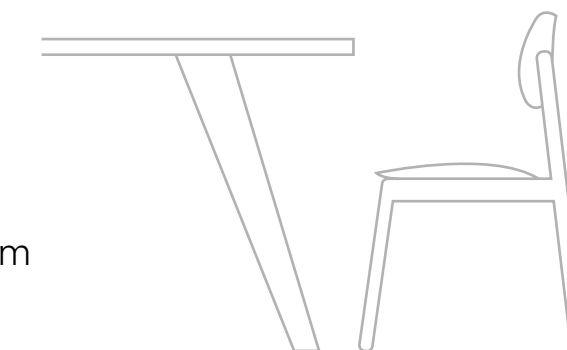
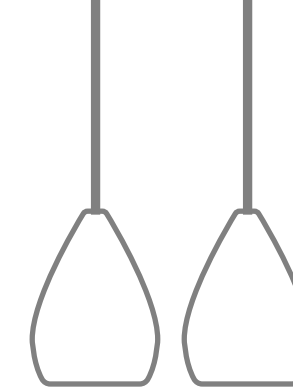

Medidas
Ancho 17cm
Alto 22cm



Bartok

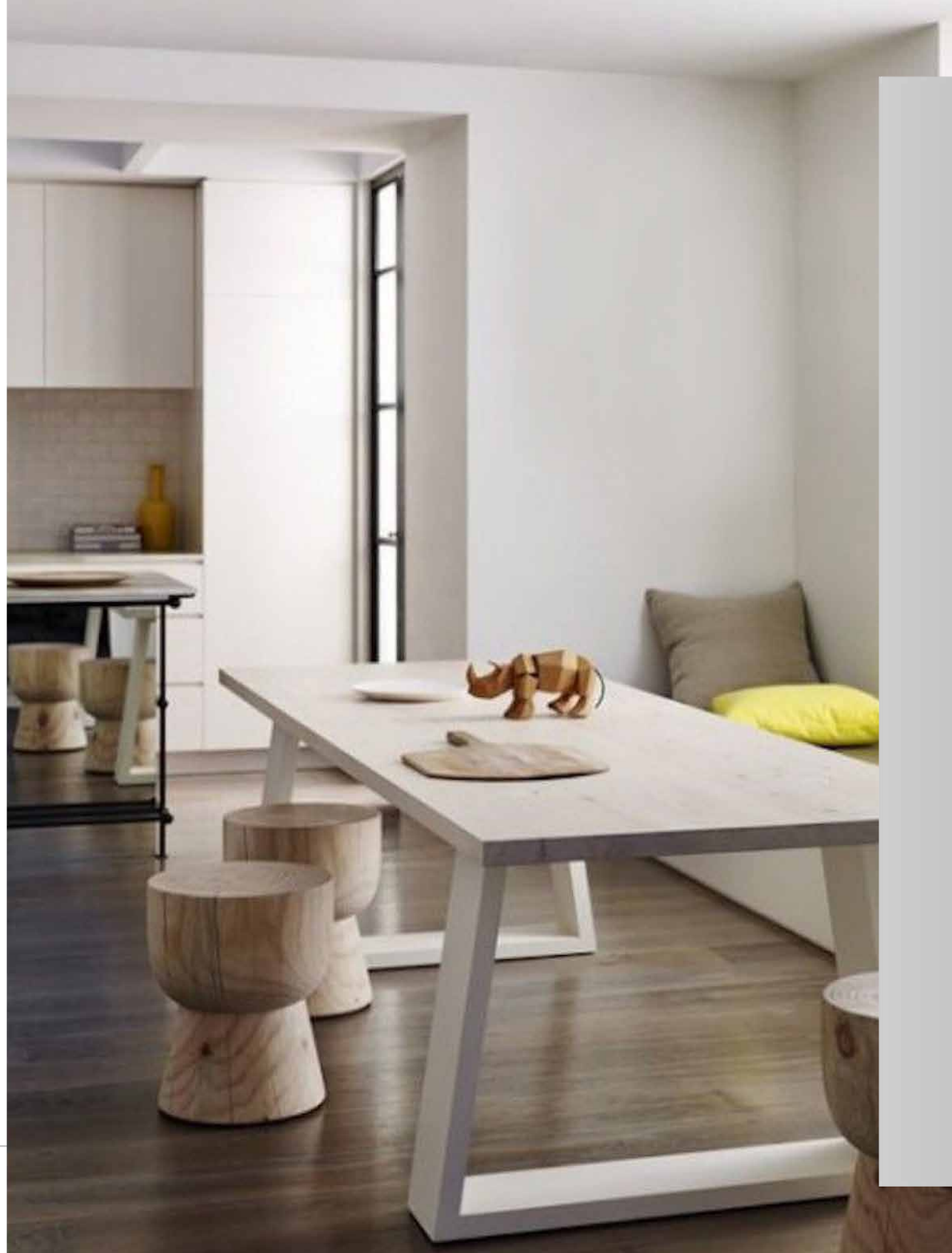



Bartok

Pieza en madera maciza de lenga torneada.
Terminación hidrolaca natural o teñido negro.
Lámpara E27 LED.

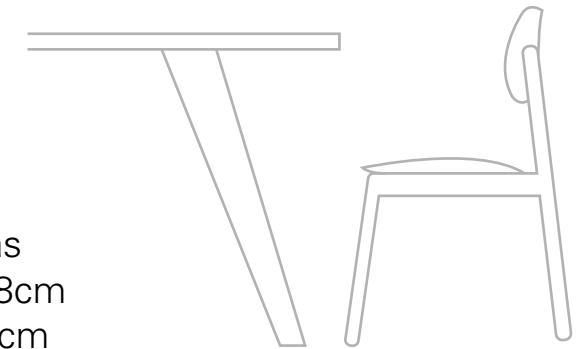
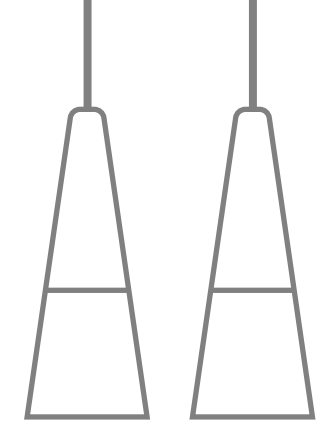

Medidas
Base 18cm
Alto 60cm



Dizzy

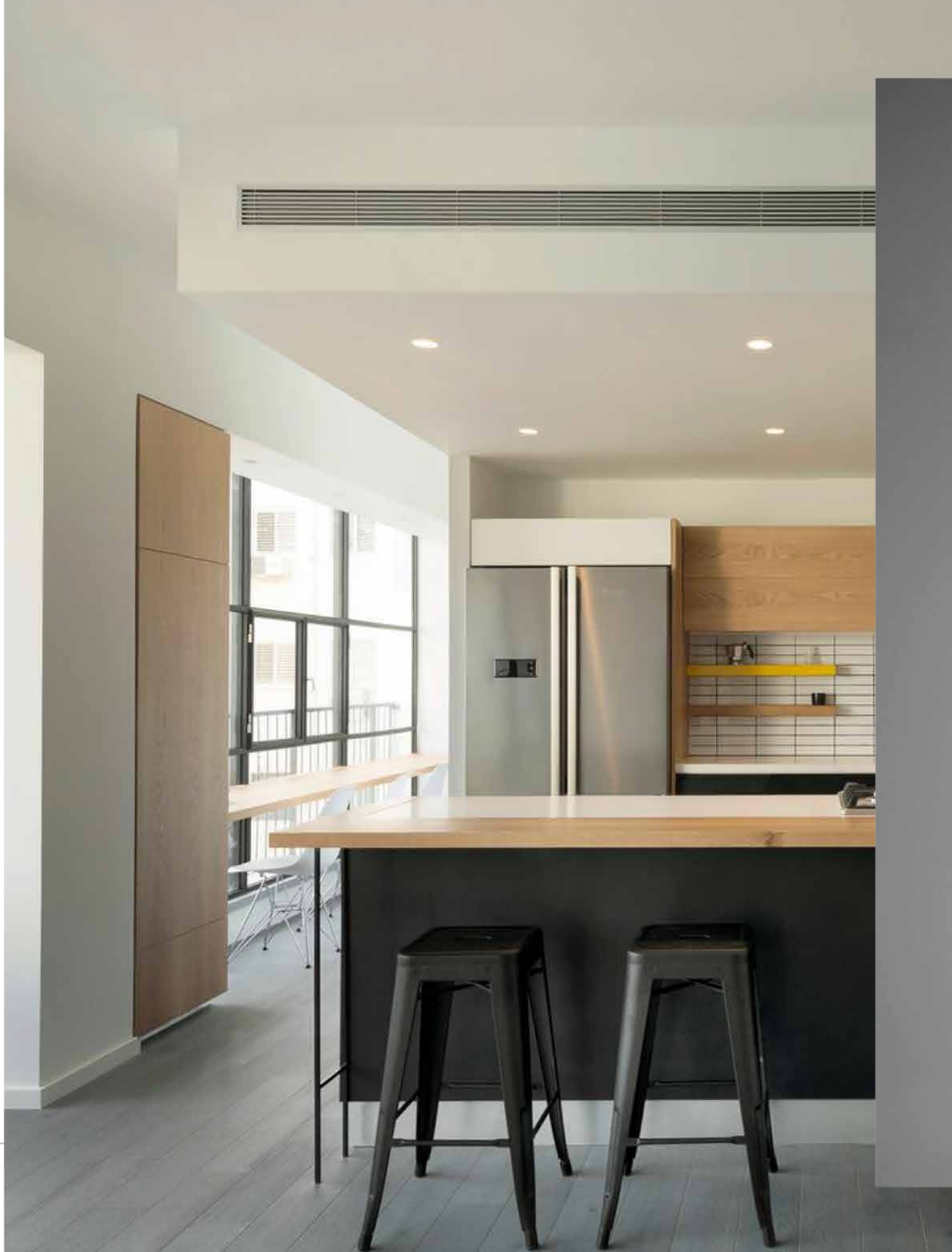



Dizzy

Pieza en madera maciza de lenga torneada.
Terminación hidrolaca natural.
Lámpara E27 LED.

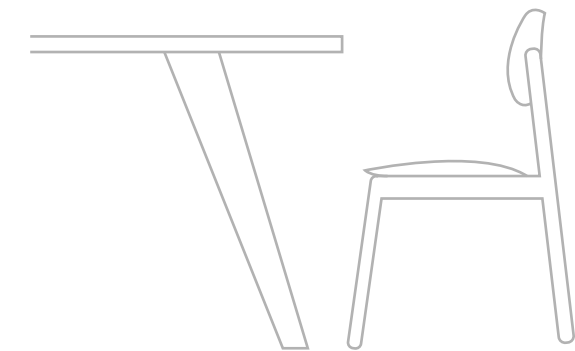
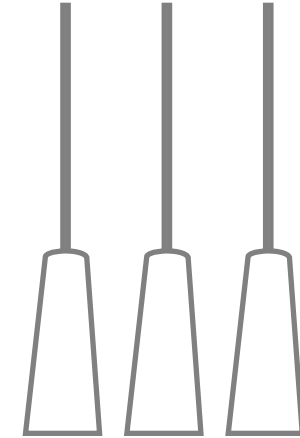

—
Medidas
Base 15cm
Alto 34cm



Ornette



Ornette

Color: Madera natural,
negro
Lámpara: dicróica LED.

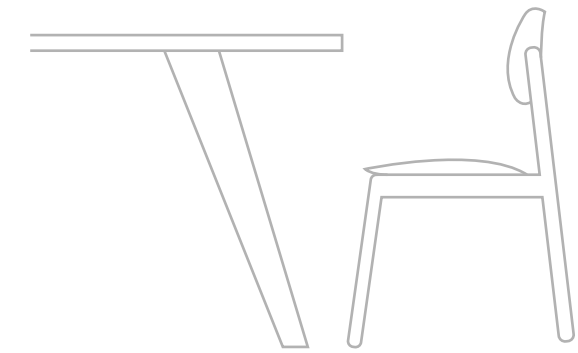
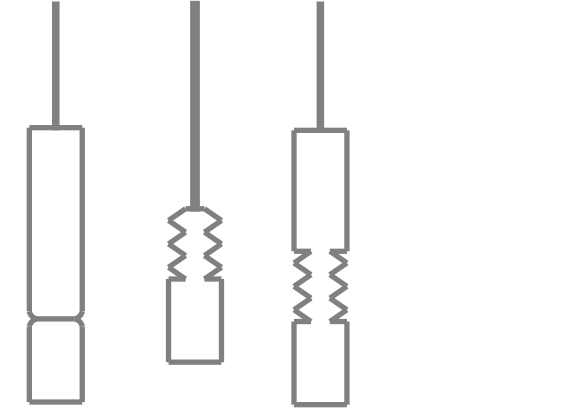

Medidas
Ancho 6,5 cm
Alto 20/35 cm

Ben





Ben

Dos piezas encastradas en madera de lenga maciza torneada.
Terminación hidrolaca natural.
Lámpara AR111 LED.

Medidas
Ancho 13cm
Alto 10cm

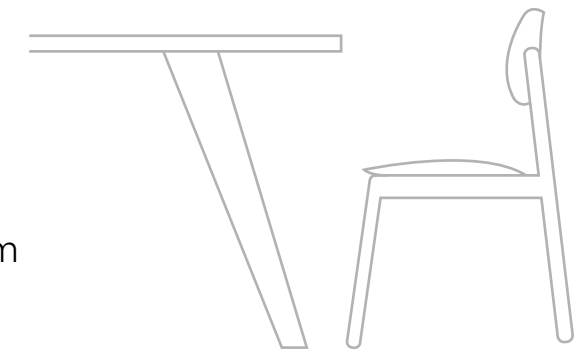

Aretha





Aretha

Campana de PLA color gris satinado.
Piezas en madera de lenga torneadas.
Terminación hidrolaca natural.
Lámpara E27 LED.

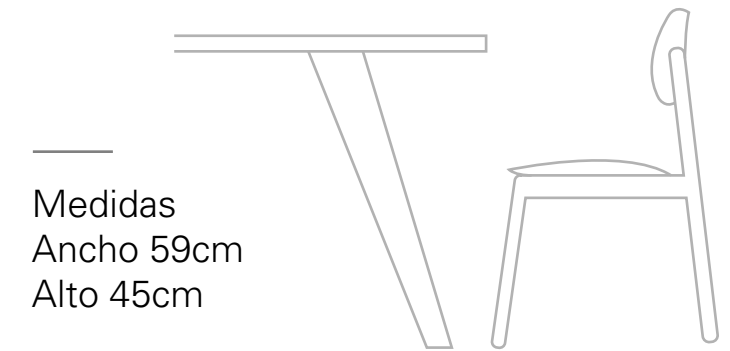
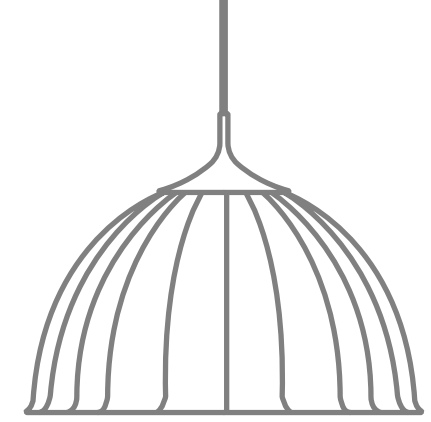

Medidas
Ancho 59cm
Alto 45cm





Luminarias para exportación

▶ Loto (página 13)

▶ Iggy (página 15)

Mini Iggy (página 17)

Cono (página 18)

▶ Oslo (página 23)

Dizzy (página 29)

Ornette (página 31)

Ben (página 33)



yucca.objetos@gmail.com

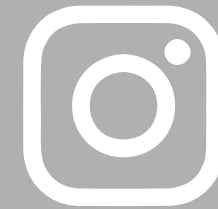

[@yucca.iluminacion](https://www.instagram.com/yucca.iluminacion)

Y U C C A